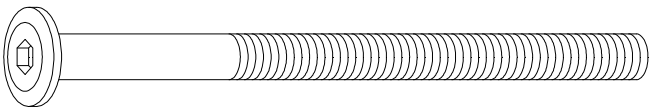
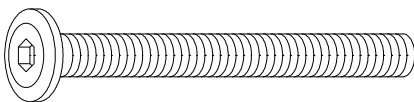
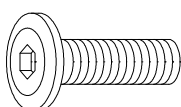
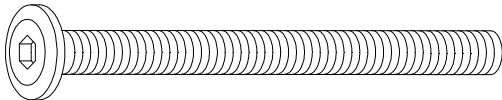
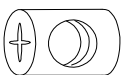
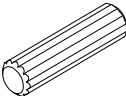
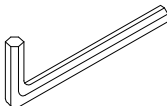

H009 Crib Hardware Identification Sheet

DO NOT assemble crib if parts and hardware are defective or missing.
Contact AFG for exchange or keep the original box for return authorization.

~ Crib Assembly Hardware

Item #	Fittings	Qty
1. Bolt M6 x 80mm		(8 pcs)
2. Bolt M6 x 45mm		(6 pcs)
3. Bolt M6 x 17mm		(4 pcs)
4. Bolt M6 x 60mm		(6 pcs)
5. Barrel Nut		(12 pcs)
6. Wood Dowel \varnothing 8*30mm		(6 pcs)
7. Wrench		(1 pc)

PHILLIPS SCREWDRIVER



(NOT INCLUDED)

H009 Crib Assembly Sheet

STEP 1:

- Insert 2 Wood Dowels (#6) into top rail of Left Side Panel (A).
- Attach Rear Left Leg (D) and Front Left Leg (F) to the Left Side Panel (A) by using 4 Bolts (#2).
- Repeat above steps to the Right Side Panel (B). Tighten firmly with Wrench (#7).

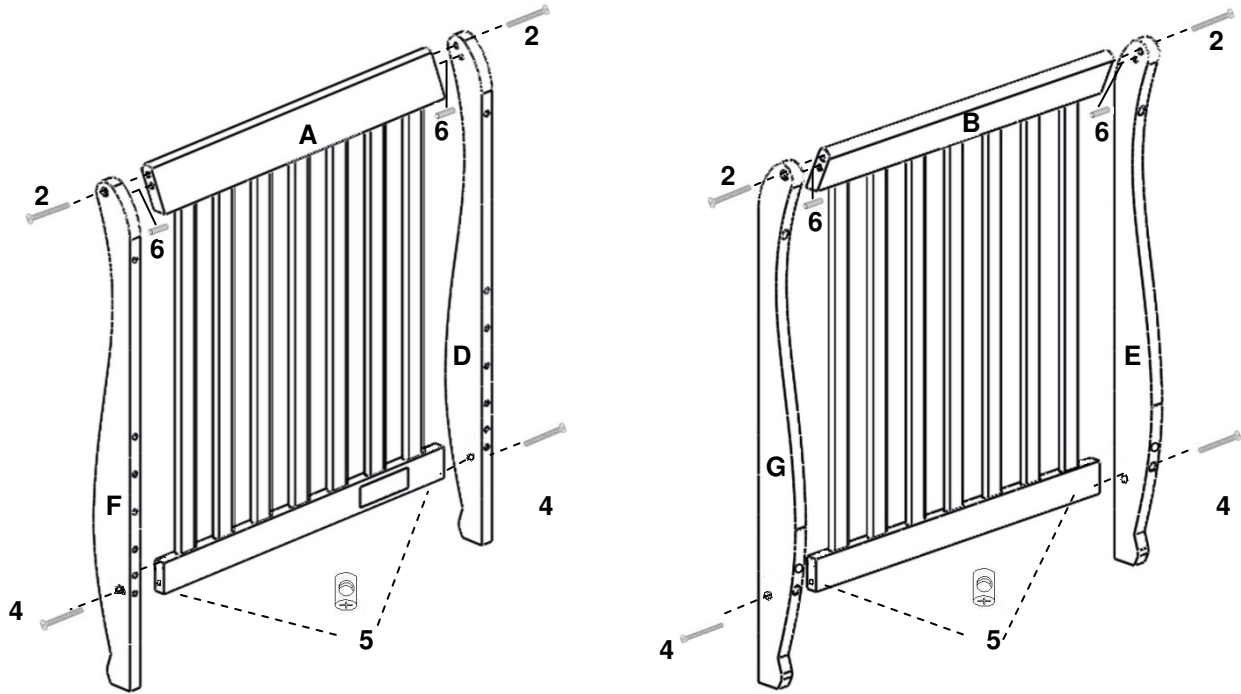

STEP 2:

Attach Rear Left Leg (D) and Rear Right Leg (E) on the side panels to the Stationary Side Panel (C) by inserting 4 Barrel Nuts (#5) on the underside of each corner of the stationary side panel before screwing 4 Bolts (#1) to secure the legs. Make sure when securing the bottom rail of the stationary side panel to the legs to insert the bolts through the lower one of the 2 holes on the legs.

