

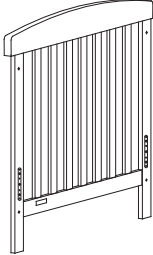

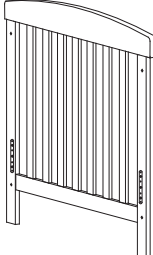
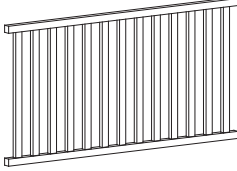
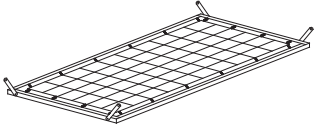

M608 Crib Parts Identification Sheet

DO NOT assemble crib if parts and hardware are defective or missing.
Contact AFG for exchange or keep the original box for return authorization.

~ Crib Assembly Parts ~

| | | | |
|--|---|---|---|
| <p>A. Left Side Panel (1 pc)</p>  | <p>B. Right Side Panel (1 pc)</p>  | <p>C. Stationary Side Panels (2 pcs)</p>  | <p>D. Mattress Support (1 pc)</p>  |
|--|---|---|---|

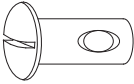
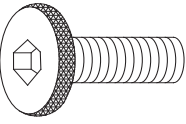
~ Crib Assembly Hardware ~



| Item # | Fittings | Qty |
|----------------------------|---|----------|
| 1. Bolt 1/4" x 2-1/4" |  | (8 pcs) |
| 2. Barrel Nut 1/4" x 20 mm |  | (8 pcs) |
| 3. Bolt 6mm x 3/4" |  | (16 pcs) |
| 4. Wrench |  | (1 pc) |

FLATHEAD SCREWDRIVER  (NOT INCLUDED)

M608 Changer Parts Identification Sheet

DO NOT assemble crib if parts and hardware are defective or missing.
 Contact AFG for exchange or keep the original box for return authorization.

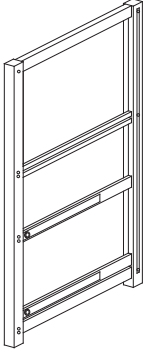
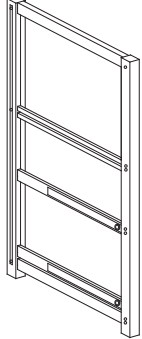
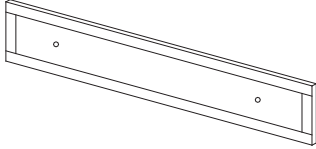
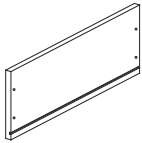
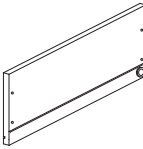
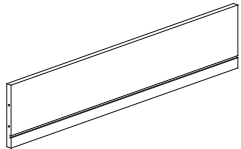
~ Changer Assembly Parts ~

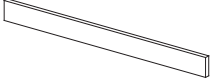
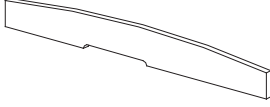
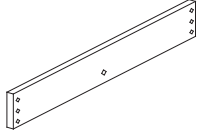
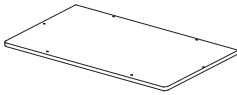
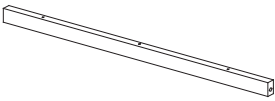
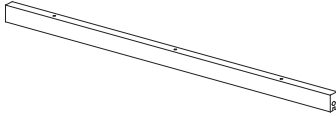
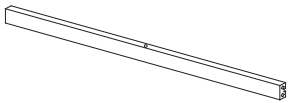
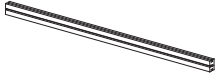
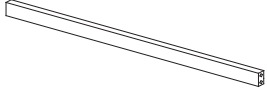
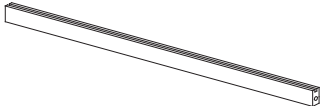
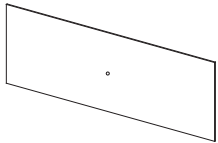
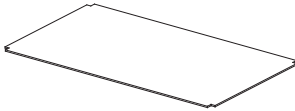
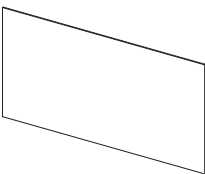
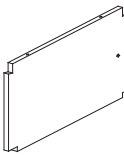
| | | | |
|--|--|--|--|
| <p>E. Left Side Panel (1 pc)</p>  | | <p>F. Right Side Panel (1 pc)</p>  | |
| <p>G. Drawer Front Panels (2 pcs)</p>  | <p>H. Drawer Left Panels (2 pcs)</p>  | <p>I. Drawer Right Panels (2 pcs)</p>  | <p>J. Drawer Back Panels (2 pcs)</p>  |
| <p>K. Drawer Bottom Panels (2 pcs)</p>  | <p>L. Top Front Panel (1 pc)</p>  | <p>M. Top Back Panel (1 pc)</p>  | <p>N. Top Side Panels (2 pcs)</p>  |
| <p>O. Top Panel (1 pc)</p>  | <p>P. Upper Front Rail (1 pc)</p>  | <p>Q. Upper Back Rail (1 pc)</p>  | <p>R. Front Shelf Rail (1 pc)</p>  |
| <p>S. Back Shelf Rail (1 pc)</p>  | <p>T. Front Drawer Rails (2 pcs)</p>  | <p>U. Back Drawer Rail (1 pc)</p>  | <p>V. Upper Back Panel (1 pc)</p>  |
| <p>W. Shelf (1 pc)</p>  | <p>X. Lower Back Panel (1 pc)</p>  | | <p>Y. Shelf Divider (1 pc)</p>  |