

PARENT SHOULD ENSURE A SAFE ENVIRONMENT FOR THEIR CHILD BY CHECKING THE FURNITURE CAREFULLY BEFORE PLACING CHILD IN THE PRODUCT. PLEASE MAKE SURE EVERY COMPONENT IS PROPERLY AND SECURELY IN PLACE.

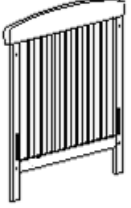

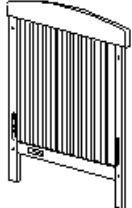
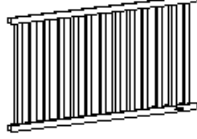
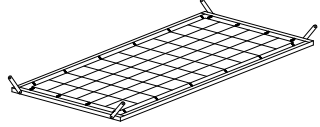

N608 Crib Parts Identification Sheet

DO NOT assemble crib if parts and hardware are defective or missing.
Contact AFG for exchange or keep the original box for return authorization.

~ Crib Assembly Parts

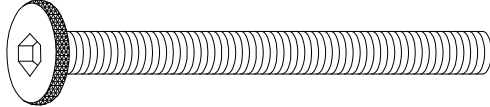
<p>A. Left Side Panel (1 pc)</p> 	<p>B. Right Side Panel (1 pc)</p> 	<p>C. Stationary Side Panels (2 pcs)</p> 	<p>D. Mattress Support (1 pc)</p> 
--	---	---	---

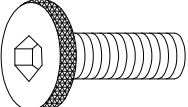
~ Crib Assembly Hardware

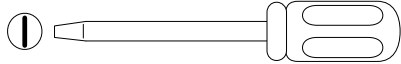

Item #	Fittings	Q'ty
1. Bolt 1/4" x 2-1/4"		(8 pcs)
2. Barrel Nut 1/4" x 15 mm		(8 pcs)
3. Bolt 6mm x 3/4"		(16 pcs)
4. Wrench		(1 pc)





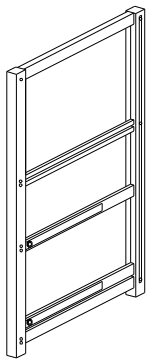
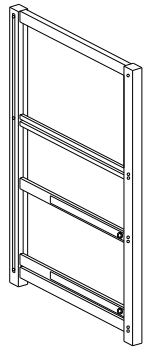
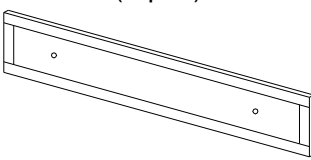
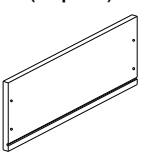
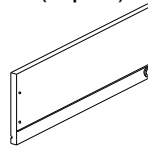
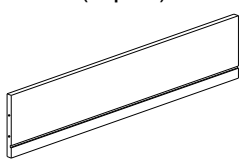
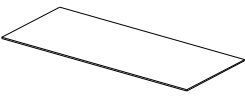
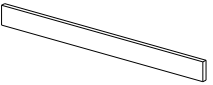
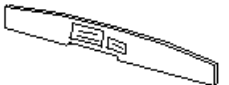
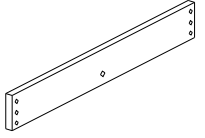
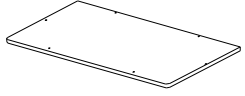
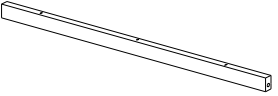
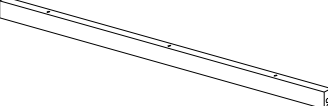
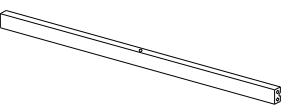

FLATHEAD SCREWDRIVER  (NOT INCLUDED)

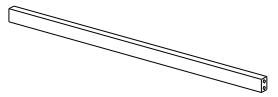
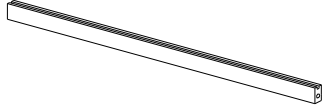
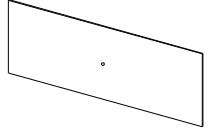
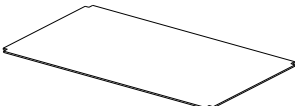
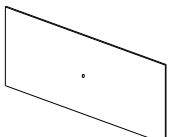
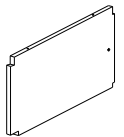
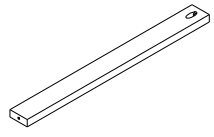
N608 Changer Parts Identification Sheet

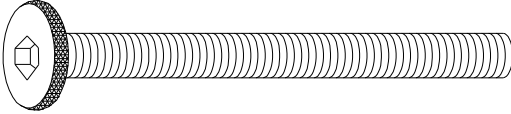
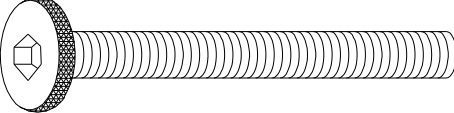
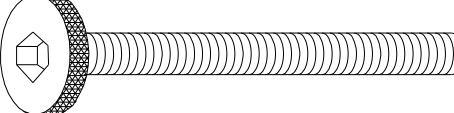
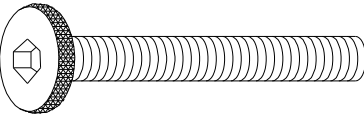
DO NOT assemble crib if parts and hardware are defective or missing.
Contact AFG for exchange or keep the original box for return authorization.

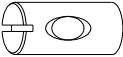
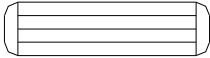
~ Changer Assembly Parts

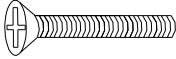
<p>E. Left Side Panel (1 pc)</p> 		<p>F. Right Side Panel (1 pc)</p> 	
<p>G. Drawer Front Panels (2 pcs)</p> 	<p>H. Drawer Left Panels (2 pcs)</p> 	<p>I. Drawer Right Panels (2 pcs)</p> 	<p>J. Drawer Back Panels (2 pcs)</p> 
<p>K. Drawer Bottom Panels (2 pcs)</p> 	<p>L. Top Front Panel (1 pc)</p> 	<p>M. Top Back Panel (1 pc)</p> 	<p>N. Top Side Panels (2 pcs)</p> 
<p>O. Top Panel (1 pc)</p> 	<p>P. Upper Front Rail (1 pc)</p> 	<p>Q. Upper Back Rail (1 pc)</p> 	<p>R. Front Shelf Rail (1 pc)</p> 
<p>S. Back Shelf Rail (1 pc)</p> 	<p>T. Front Drawer Rails (2 pcs)</p> 	<p>U. Back Drawer Rail (1 pc)</p> 	<p>V. Upper Back Panel (1 pc)</p> 
<p>W. Shelf (1 pc)</p> 	<p>X. Lower Back Panel (1 pc)</p> 	<p>Y. Shelf Divider (1 pc)</p> 	<p>Z. Drawer Support (2 pcs)</p> 

Item #	Fittings	Qty
5. Bolt 1/4" x 2-1/2"		(14 pcs)
6. Bolt 1/4" x 2-1/4"		(6 pcs)
7. Bolt 1/4" x 2-1/4"		(4 pcs)
8. Bolt 1/4" x 1-3/4"		(1 pc)
9. Barrel Nut 1/4" x 15mm		(14 pcs)
10. Barrel Nut 1/4" x 13 mm		(11 pcs)
11. Dowel 8mm x 30mm		(17 pcs)
12. Screw F4 x 25 mm		(20 pcs)
13. Machine Screw 3/16" x 1"		(6 pcs)
14. Knob		(4 pcs)
15. Bolt 5/32" x 3/4"		(4 pcs)

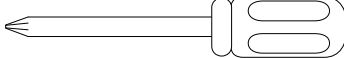
PHILLIPS SCREWDRIVER   (NOT INCLUDED)

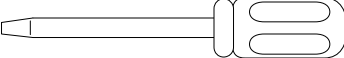
FLATHEAD SCREWDRIVER   (NOT INCLUDED)